

MODEL 61S-xxx-S ; 6" DIRECT MOUNTING (BOTTOM VERTICAL) SOLID FRONT ST.ST GAUGE 1/2"NPT CONNECTION

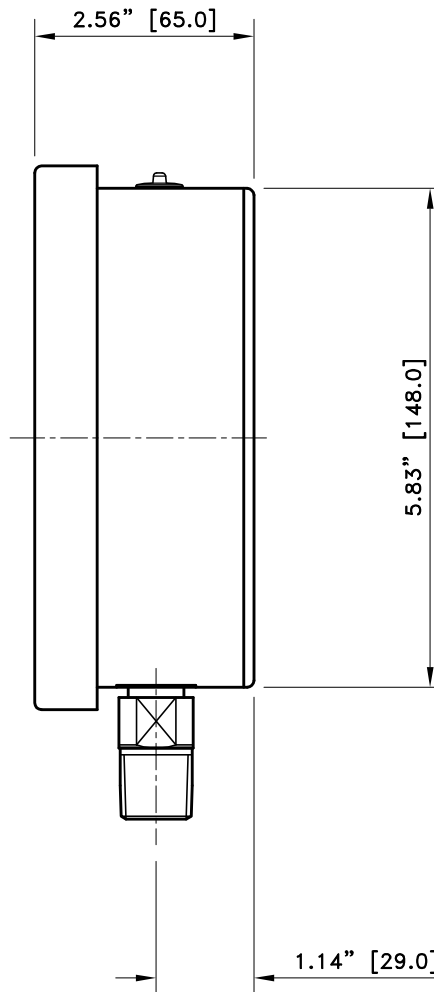
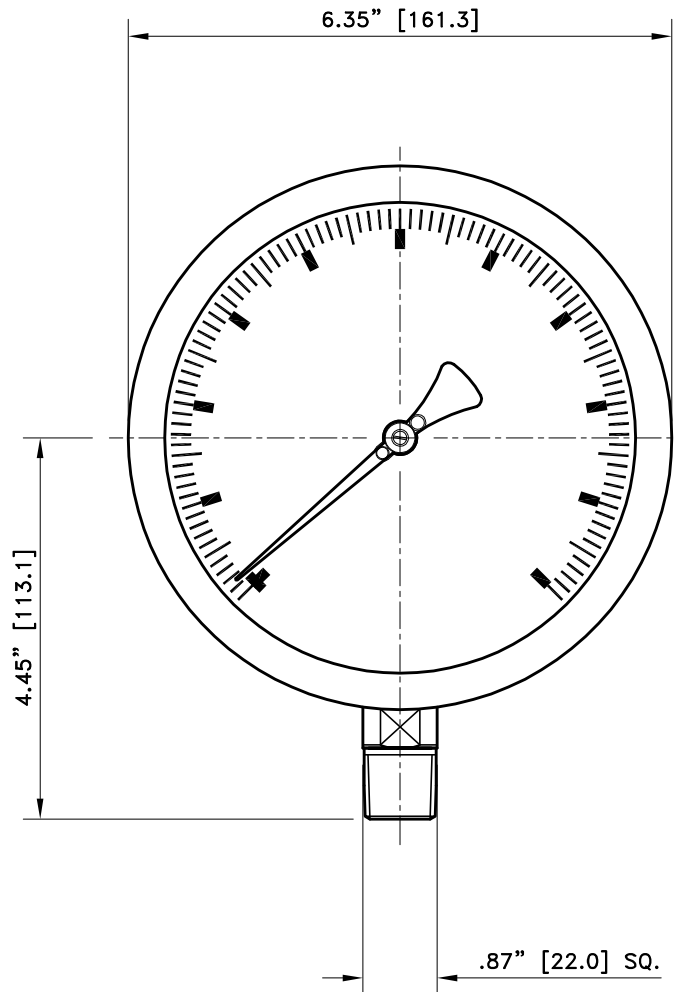

SOLID-FRONT BETWEEN BOURDON-TUBE AND DIAL.

BLOW-OUT BACKPLATE.

LAMINATED SAFETY GLASS WINDOW.

WHITE ALUMINUM DIAL, BLACK FIGURES.

BLACK ALUMINUM ADJUSTABLE POINTER.

AISI 316 STAINLESS STEEL WETTED PARTS.

AISI 316 STAINLESS STEEL CASE.

AISI 316 STAINLESS STEEL BAYONET RING.

PULSATION RESTRICTOR IN SOCKET.

ACCURACY $\pm 0.5\%$ OF FULL SCALE, UP TO 10,000 PSI PER ASME B40.1 GRADE 2A.

© STEWARTS-USA 2005

Stewarts-USA own this drawing and the Copyright of the same. It is conditionally loaned and by receiving it the recipient has agreed not to copy or reproduce in whole or part, not to supply information from it nor utilize it for any purpose that is not the subject of agreement in writing by Stewarts-USA. Upon request this drawing must be returned.

THIRD ANGLE PROJECTION

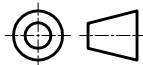

STEWARTS-USA
6786 Tipperary
HOUSTON, TX 77061 U.S.A
Phone.713-643-1022
Fax. 713-643-2855
Toll Free. 1-800-901-1316



NEW ORLEANS
(504) 737-3551 VOICE
(504) 737-3558 FAX

07.04.05	MC	SR	AS BUILT	0
DATE	BY	AUTH	AMENDMENTS	REVISION

DRAWING No.

61S-xxx-S